

# COUP D'ETAT



## **Armor Pendant Five Cluster - Small**

**by konekt**

*Contemporary*

United States

The Armor Pendant features a carefully crafted hand-blown glass pendant draped with finished stainless steel chainmail. Pulling from the intricate use of chainmail in Medieval armor, KONEKT reinterprets its materiality by creating a balance between the strength that the metal mesh evokes and the delicate and elegant nature of hand-blown glass. Available in two sizes as a single pendant, a cluster of three or five pendants, or a custom cluster.

### **Dimensions:**

Canopy: 18"D

Overall Diameter: 21"D

Overall Drop Length: Up to 78"H\*

Drop length cut to order.\*

**Materials:** Hand-blown Glass, Brass and Finished Stainless Steel Chainmail

111 Rhode Island Street, Suite 1 San Francisco, CA 94103 P. 415 241 9300

100 N Robertson Blvd, Los Angeles, CA 90048 P. 323 825 5880

E. [info@coupdetatsf](mailto:info@coupdetatsf) **COUPDETATSE.COM**

# COUP D'ETAT



**Armor Pendant Five Cluster - Small**  
by konekt

*Contemporary*  
United States

**Finish:** Satin Brass, Antique Brass\*, Oil-rubbed Bronze\*,  
Satin Black\*, Satin Nickel\* or Antique Nickel\*  
(Upcharge for Premium finishes\*)

**Lamping:** E12 | 120V | 60W  
9.5W dimmable LED bulb included  
120V; 950 lumens; 2700k color temperature

UL listed

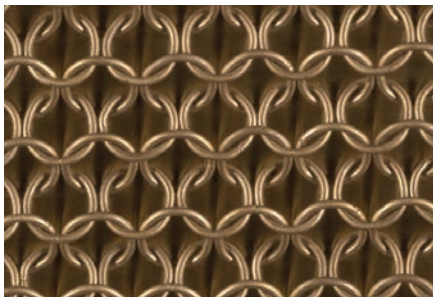
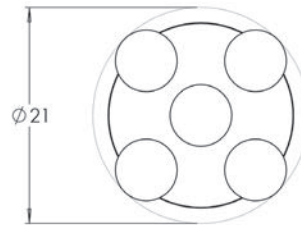
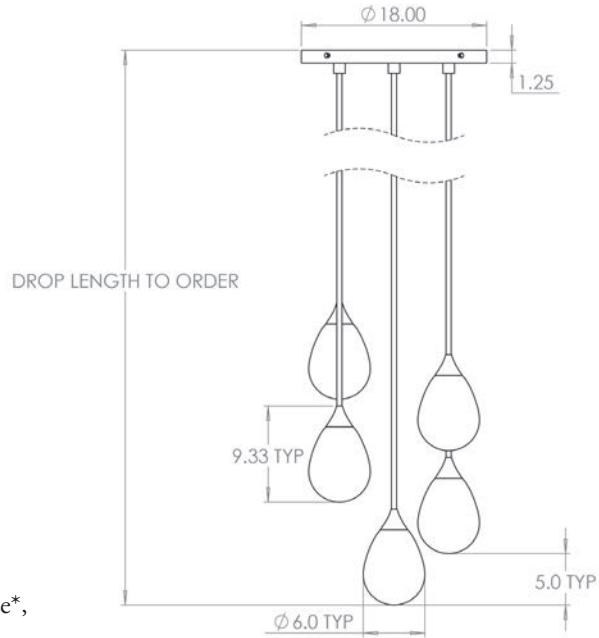

Satin Brass Chainmail

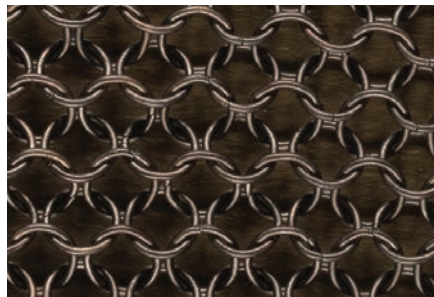

Antique Brass Chainmail\*

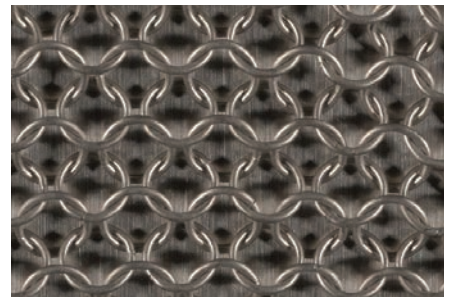

Satin Nickel Chainmail\*

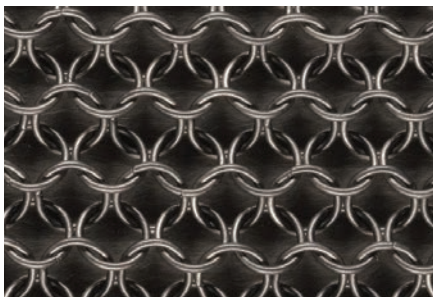

Antique Nickel Chainmail\*

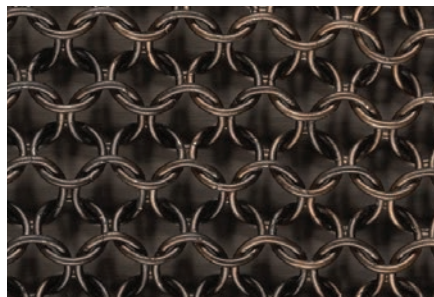

Oil-Rubbed Bronze Chainmail\*

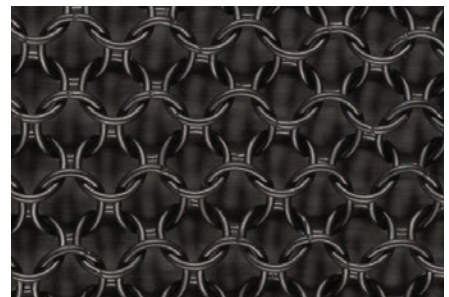

Satin Black Chainmail\*