



Armor Pendant - Small 3 Cluster

by Konekt

Contemporary

United States

The Armor Pendant features a carefully crafted hand-blown glass pendant draped with finished stainless steel chainmail. Pulling from the intricate use of chainmail in Medieval armor, we reinterpret its materiality by creating a balance between the strength that the metal mesh evokes and the delicate and elegant nature of hand-blown glass. Available in two sizes as a single pendant, a cluster of three or five pendants, or a custom cluster.

Dimensions: 12" D

Materials: Hand-blown Glass, Brass and Finished Stainless Steel Chainmail.

UL listed.

ARMOR PENDANT - SMALL 3 CLUSTER

COUP D'ETAT

DESCRIPTION	DIMENSIONS	LAMPING	INCLUSIONS
-------------	------------	---------	------------

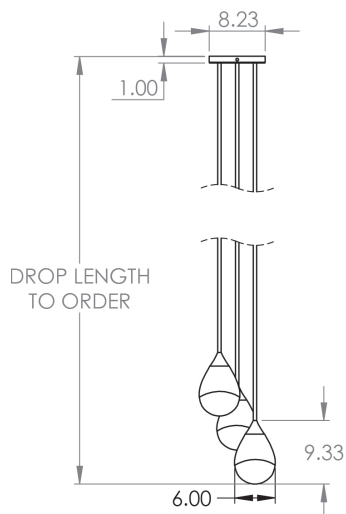

12" D
 *Drop length cut to order.

E12 | 120V | 60W

9.5W dimmable LED bulb included
 120V; 950 lumens; 2700k

CHAINMAIL:

- Satin Brass
- Antique Brass
- Oil-rubbed Bronze
- Satin Black
- Satin Nickel
- Antique Nickel

ADDITIONAL:

UL listed.
 Pricing includes up to 78" H. For longer drop lengths inquire for custom quote.

Chainmail Options for Armor Collection

by Konekt

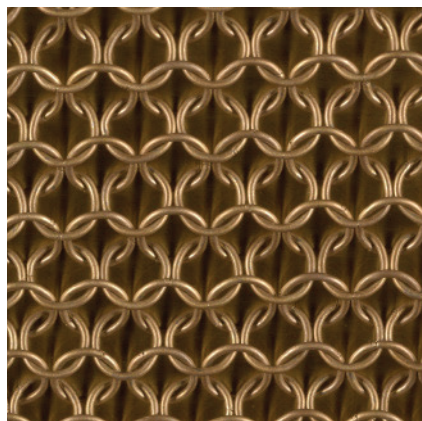

Satin Brass

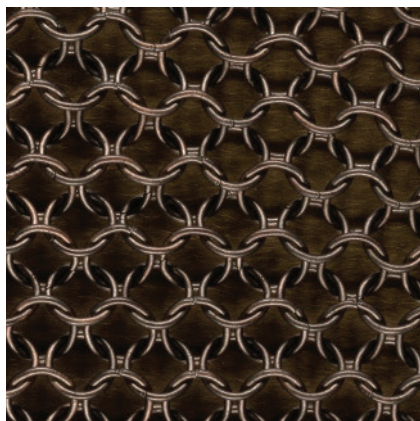

Antique Brass

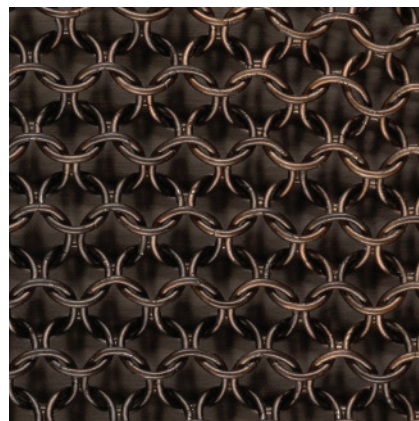

Oil-Rubbed Bronze

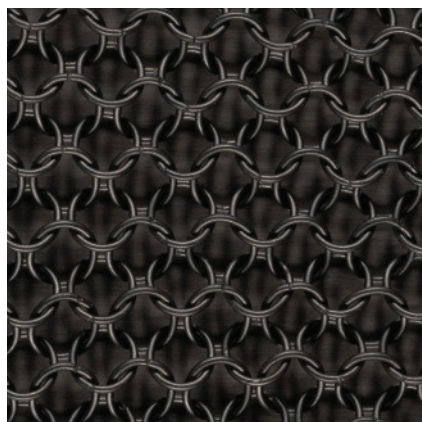

Satin Black

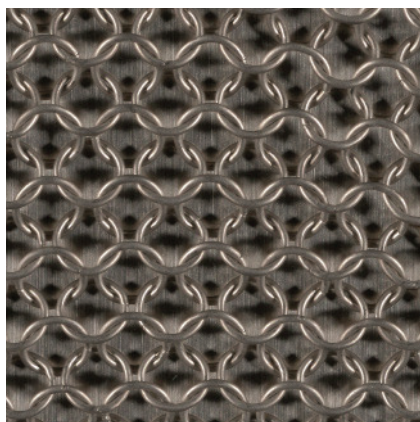

Satin Nickel

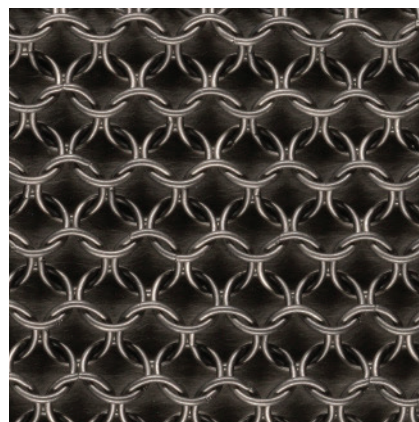

Antique Nickel

CHAINMAIL:

Konekt's Armor Collection features furniture and lighting designs that are draped in cloaks of stainless steel chainmail. Working with an American company that has been producing chainmail since 1876, we create chainmail patterns to hug the shape and size of each design. Panels of chainmail are made by machine, and then joined by hand to create a pattern. We've established our own unique finishing process, allowing us to offer extensive finish options for clients to choose from.